

# W 200 SPRAY GUN



**GB** Before use, adjustment or maintenance, it is important to read this instruction manual very carefully. This manual must be stored in a safe place for any future reference that may be necessary.

This **ANEST IWATA** spray guns kit complies to ATEX regulations 94/9/EC, protection level: II 2 G X Suitable for using Zones 1 and 2.



X marking: Any static electricity discharge from the spray gun is to be diverted to the ground via the conductive air hose as stipulated.

## IMPORTANT

This spray gun should be operated only by an adequately trained operator, for safe use and maintenance of the equipment. Any misuse or handling other than those indicated in this Instruction Manual is not covered by guarantee. ANEST IWATA disclaims all responsibility for any accident or damage caused by failure to observe the operational and safety procedures in this manual. In the interest of user friendliness, this manual contains information in a brief and concise form. For any additional information you may require regarding spray gun operations, or if any missing parts or any damage during transportation is found, please contact your nearest ANEST IWATA Company (see last cover page).

Be sure to observe warnings and cautions in this instruction manual.  
If not, it can cause paint ejection and serious bodily injury by drawing organic solvent.  
Be sure to observe following marked items which are especially important.

<b>WARNING</b>	Indicates a potentially hazardous situation which, if not avoided, may result in serious injury or loss of life.
<b>CAUTION</b>	Indicates a potentially hazardous situation which, if not avoided, may result in minor or moderate injury or property damage.
<b>IMPORTANT</b>	Indicates notes which we ask you to observe. The safety precautions in this instruction manual are the minimum necessary conditions. Follow national and local regulations regarding fire prevention, electricity and safety as well as your own company regulations.

## IMPORTANT SPECIFICATIONS

Max. Pressure:	6.8 bar (98 PSI)	Max. Temperature:	
Noise Level (LAeqT)	81.2 dB (A)	Atmosphere	5 ~ 40 °C
Spray conditions	Recommended	Air and fluid	5 ~ 43 °C
Measuring point	1m backwards from gun, 1,6 m height	Air connection:	G 1/4"
		Fluid connection:	G 3/8"

## TECHNICAL SPECIFICATIONS

Model	Nozzle orifice mm (in)	Air pressure at gun inlet bar (PSI)	Air consumption l/min (cfm)	Fluid output ml/min	Pattern width mm (in)	Air Cap set Mark	Weight g	
<b>High T.E.C. W200 Pressure feed</b>								
W200-082P	0.8 (0.031)	2.0 (29)	360 (12.7)	255	280 (11.0)	LV2	380	
W200-102P	1.0 (0.039)	2.0 (29)	360 (12.7)	255	280 (11.0)	LV2		
W200-122P	1.2 (0.047)	2.0 (29)	360 (12.7)	255	280 (11.0)	LV2		
W200-082P	0.8 (0.031)	3.0 (43)	560 (19.8)	500	400 (15.7)	G2P		
W200-102P	1.0 (0.039)	3.0 (43)	560 (19.8)	500	400 (15.7)	G2P		
W200-122P	1.2 (0.047)	3.0 (43)	560 (19.8)	500	400 (15.7)	G2P		
<b>High T.E.C. W200 Suction feed</b>								
W200-152S	1.5 (0.059)	3.0 (43)	330 (11.7)	240	290 (11.4)	K2		
W200-182S	1.8 (0.071)	3.0 (43)	330 (11.7)	290	340 (13.4)	K2		
W200-202S	2.0 (0.079)	3.0 (43)	360 (12.7)	350	290 (11.4)	R2		
W200-251S	2.5 (0.098)	3.0 (43)	500 (17.7)	760	370 (14.6)	W1		

Manufactured by:  
**ANEST IWATA Corporation** 3176, Shinyoshida-cho, Kohoku-ku, Yokohama, 223-8501 Japan

**ANEST IWATA Europe S.r.l.**  
Corso Vigevano, 46 - 10155, Torino (Italy)  
Direct Tel. +39 011 - 22 74 402  
Fax +39 011 - 22 74 000  
info@anest-iwataeu.com  
www.anest-iwataeu.com

**ANEST IWATA Italia S.r.l.**  
Corso Vigevano, 46 - 10155, Torino (Italy)  
Tel. diretto +39 011 - 24 80 868 - Fax: +39 011 - 85 19 44  
info@anest-iwata.it www.anest-iwata.it

**ANEST IWATA Iberica**  
Calle de Les Teixidores, 3-5  
08918 - Badalona (Barcelona)  
Tel. +34 93 32 05 993 - Fax: +34 93 32 05 965  
info@anest-iwata.es www.anest-iwata.es

**ANEST IWATA Deutschland**  
Mommensenstrasse 5  
04329 Leipzig  
Telefon: +49 (0)341 241 44 30 - Fax: +49 (0)341 252 55 95  
info@anest-iwata.de www.anest-iwata.de

## European Sales Branches:

**ANEST IWATA Scandinavia**  
Ögärdesvägen 6C, 433 30 PARTILLE - Sweden  
Tel. +46 (0)31 - 340 28 60 - Fax +46 (0)31 - 340 28 69  
info@anest-iwata.se www.anest-iwata.se

**ANEST IWATA France**  
25 rue de Madrid - 38070 St Quentin Fallavier - France  
Tél. +33 (0)4 - 74 94 59 69 - Fax +33 (0)4 - 74 94 34 39  
info@anest-iwata.fr www.anest-iwata.fr

**ANEST IWATA U.K.**  
7 Chester Road, Colmworth Business Park, Eaton Socon  
St Neots - CAMBRIDGESHIRE  
PE19 8YT  
Tel.: +44 (0) 1480 40 54 19 Fax: +44 (0) 1480 21 76 10  
enquiries@anest-iwata.co.uk www.anest-iwata.co.uk



# SPARE PARTS LIST

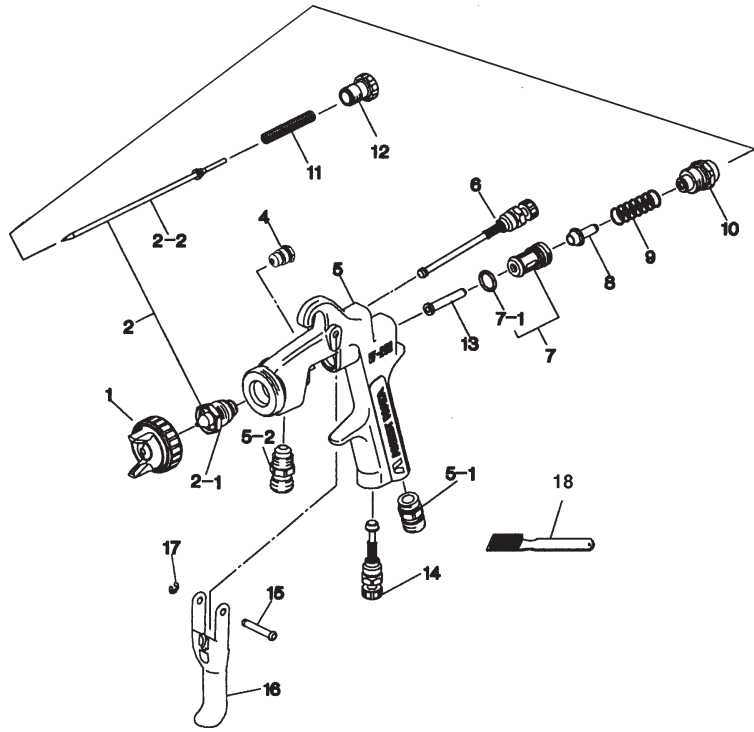

## PARTS LIST

DESCRIPTION	REF.PART
AIR CAP SET	1
NOZZLE+ NEEDLE SET	2 ●
FLUID NOZZLE	2-1 ●
FLUID NEEDLE SET	2-2 ●
NEEDLE PACKING CARTRIDGE	4 ●
BODY SET	5
AIR NIPPLE	5-1
FLUID NIPPLE	5-2
PATTERN ADJ. SET	6
AIR VALVE SEAT SET	7
O RING	7-1 ●
AIR VALVE	8 ●
AIR VALVE SPRING	9
FLUID ADJ. GUIDE	10
FLUID NEEDLE SPRING	11
FLUID ADJ. KNOB	12
AIR VALVE SHAFT	13 ●
AIR ADJ. SET	14
PLUG	14-1
TRIGGER STUD	15
TRIGGER	16
E STOPPER	17
BRUSH	18

## FLUID NOZZLE-FLUID NEEDLE SET COMBINATION

Fluid nozzle		Fluid needle set
Orifice mm(in)	Mark	Mark
0.8 (0.031)	W200/08	20012 H
1.0 (0.039)	W200/10	20012
1.2 (0.047)	W200/12	20012
1.4 (0.055)	W200/14	20015
1.5 (0.059)	W200/15	20015
1.8 (0.071)	W200/18	20020
2.0 (0.079)	W200/20	20020
2.5 (0.100)	W200/25	20025

### ● Marked parts are wearable parts.

**NOTE:** When ordering parts, specify gun's model, part name with ref. No. and marked No. of air cap set, fluid nozzle and fluid needle. When replacing fluid nozzle or/and fluid needle for pressure feed application, please order nozzle needle set.



## OTHER PRECAUTIONS

### 3. Never spray foods or chemicals through this gun.

If done, it can cause accident by corrosion of fluid passages or adversely affect health by mixed foreign matter.

### 4. If something goes wrong, immediately stop operation and find the cause. Do not use again until you have solved the problem.

# HOW TO CONNECT



## CAUTION

- Use clean air filtered through air dryer and air filter. If not, dirty air can cause painting failure.
- When you use this gun for the first time after purchasing, adjust fluid needle packing set. Slowly tighten fluid packing seat and loosen a bit when fluid needle set does not return smoothly, and adjust so that fluid needle set smoothly moves.
- When you use this gun for the first time after purchasing, clean fluid passages spraying cleaner and remove rust preventive oil. If not, remaining rust preventive oil can cause painting failure such as fish eyes.
- Firmly fix hose or container to spray gun. If not, disconnection of hose and drop of container can cause bodily injury.

1. Connect an air hose to air nipple tightly.
2. Connect a fluid hose or a container to fluid nipple tightly.
3. Flush the gun fluid passages with a compatible cleaner.
4. Pour paint into container, test spray and adjust fluid output as well as pattern width.

# HOW TO OPERATE

Suggested air pressure is 2.0 to 3.5 bar (29 to 50 PSI)

Recommended paint viscosity differs according to paint property and painting conditions. 15 to 23 sec. / Ford cup#4 is recommendable.

Keep fluid output as small as possible to the extent that the job will not be hindered. It will lead to better finishing with fine atomization.

Set the spray distance from the gun to the work piece as near as possible within the range of 200\_250 mm (7.9\_9.8 in).

The gun should be held so that it is perpendicular to the surface of the workpiece at all times. Then, the gun should move in a straight and horizontal line. Arcing the gun causes uneven painting.

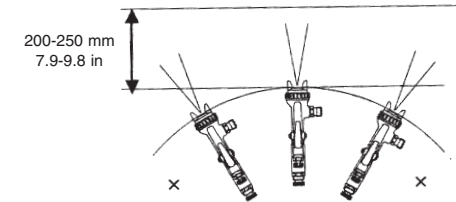

# MAINTENANCE AND INSPECTION



## WARNING

- First release air and fluid pressure fully according to item No. 3 of "Improper use of equipment" of WARNING on page 2.
- Tip of fluid needle set has a sharp point. Do not touch the tip of needle valve during maintenance for protection of the human body.
- Be careful not to damage the tip of the fluid nozzle or put your hand on it.
- Only an experienced person who is fully conversant with the equipment can do maintenance and inspection.







## CAUTION

- Never use commercial or other parts instead of ANEST IWATA original spare parts.
- Never immerse the whole gun into fluid such as cleaner.
- Never damage holes of air cap, fluid nozzle or fluid needle.

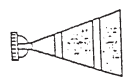
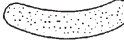
Step-by-step procedure	Important
1. Pour remaining paint to another container. Clean fluid passages and air cap set. Spray a small amount of cleaner to clean fluid passages.	1. Incomplete cleaning can fail pattern shape and uniform particles. Especially clean fully and promptly after use with two-component paint.
2. Clean each section with brush soaked with cleaner and wipe out with waste cloth.	2. Do not immerse the whole gun in cleaner. If done, it can damage parts. When cleaning, never scratch any holes of air cap set, fluid nozzle, or fluid needle set.
3. Before disassembly, fully clean fluid passages. (1) Disassemble fluid nozzle.  (2) Disassemble fluid needle set.  You do not need to remove fluid adj. guide set from gun body. Remove fluid adj. knob and fluid needle spring, then pull out fluid needle spring, and then pull out fluid needle set from back of fluid adj. guide set.	3. During disassembly, do not scratch seat section. (1) Remove fluid nozzle after removing fluid needle set or while keeping fluid needle pulled, in order to protect seat section. (2) Be careful when handling tip of fluid needle set since it is sharp. Disassemble fluid adj. guide set as little as possible.
4. The fluid needle packing set, must be adjusted while the fluid needle set is inserted. Tighten fluid needle packing seat by hand and then tighten further by spanner.	4. Too much tightening of fluid needle packing set can cause bad movement of fluid needle set and fluid leakage from the tip of fluid needle set.
5. In order to assemble air valve, first assemble air valve & air valve spring & fluid adj. guide set together. Next, insert fluid needle set into fluid adj. guide set, then fit it to gun body set and screw fluid adj. guide set.	5. If you try to fit air valve spring and air valve to gun body set without fluid needle set, air valve will not be fitted correctly and packing inside fluid adj. guide set will be damaged.
6. Turn pattern adj. knob counterclockwise to fully open. Then tighten pattern adj. set or air adj. set.	6. If pattern adj. knob is not fully opened, tip of it can brush against and damage fluid nozzle and cause seizure of thread.
<b>Where to inspect</b>	<b>Parts replacement standard</b>
1. Each hole passage of air cap and fluid nozzle	Replace if it is crushed or deformed.
2. Packings and O rings	Replace if it is deformed or worn out.
3. Leakage from seat section between fluid nozzle and fluid needle set	Replace them if leakage does not stop after fully cleaning fluid nozzle and fluid needle set. If you replace fluid nozzle or fluid needle only, fully match them and confirm that there is no leakage.

# TROUBLESHOOTING

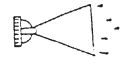
Spray Pattern	Problems	Remedies
 <b>Fluttering</b>	<ol style="list-style-type: none"> <li>1. Air enters between fluid nozzle and tapered seat of gun body.</li> <li>2. Air is drawn from fluid needle packing set</li> <li>3. Air enters at fluid container fitting nut or fluid hose joint.</li> </ol>	<ol style="list-style-type: none"> <li>1. Remove fluid nozzle to clean seat. If it is damaged, replace nozzle.</li> <li>2. Tighten fluid needle packing.</li> <li>3. Fully tighten joint section.</li> </ol>
 <b>Crescent</b>	<ol style="list-style-type: none"> <li>1. Paint buildup on air cap partially clogs horn holes. Air pressure from both horns differs.</li> </ol>	<ol style="list-style-type: none"> <li>1. Remove obstructions from horn holes with attached brush. But do not use metal objects to clean horn holes.</li> </ol>
 <b>Inclined</b>	<ol style="list-style-type: none"> <li>1. Paint buildup or damage on fluid nozzle circumference and air cap center.</li> <li>2. Fluid nozzle is not properly fitted.</li> </ol>	<ol style="list-style-type: none"> <li>1. Remove obstructions. Replace if damaged.</li> <li>2. Remove fluid nozzle, clean seated section</li> </ol>
 <b>Split</b>	<ol style="list-style-type: none"> <li>1. Paint viscosity too low.</li> <li>2. Fluid output too high.</li> </ol>	<ol style="list-style-type: none"> <li>1. Add paint to increase viscosity.</li> <li>2. Tighten fluid adj. knob to reduce fluid output or turn pattern adj. knob clockwise.</li> </ol>
 <b>Heavy Center</b>	<ol style="list-style-type: none"> <li>1. Paint viscosity is too high.</li> <li>2. Fluid output is too low.</li> </ol>	<ol style="list-style-type: none"> <li>1. Add thinner to reduce viscosity.</li> <li>2. Turn fluid adj. knob counter-clockwise to increase fluid output.</li> </ol>
 <b>Spit</b>	<ol style="list-style-type: none"> <li>1. Fluid nozzle and fluid needle set are not seated properly.</li> <li>2. The first-stage travel of trigger (when only air discharges) decreases.</li> <li>3. Paint buildup inside air cap set.</li> </ol>	<ol style="list-style-type: none"> <li>1. Clean or replace fluid nozzle and fluid needle set.</li> <li>2. Replace fluid nozzle and fluid needle set.</li> <li>3. Clean air cap set.</li> </ol>

# PROBLEMS AND REMEDIES

Problem	Where it occurred	Parts to be checked	Cause	Remedy			
				Tighten	Adjust	Clean	Replace
Air leaks (from tip of air cap)	Air valve set	Air valve	*Dirt or damage on seat			x	x
		Air valve seat set	*Dirt or damage on seat			x	x
		O ring	*Wear on air valve spring				x
Paint leaks	Fluid nozzle	Fluid nozzle - fluid needle set	*Dirt, damage, wear on seat			x	x
			*Loose fluid needle adj. knob		x		
		*Wear on needle spring				x	
		Fluid nozzle - gun body	*Insufficient tightening	x			
	Fluid needle - packing set	*Dirt or damage on seat			x	x	
		*Needle does not return due to packing set too tight			x	x	
Fluid needle	*Needle does not return due to paint buildup on fluid needle				x	x	
	Needle packing set, needle set	*Wear	x			x	
Paint does not flow	Tip of gun	Packing seat	*Insufficient tightening	x			
		Fluid adj. knob	*Insufficient opening		x		
		Tip hole of nozzle	*Clogged			x	
		Paint filter	*Clogged			x	x